

POWtec CEE Panel Mounted Socket Outlets IP67

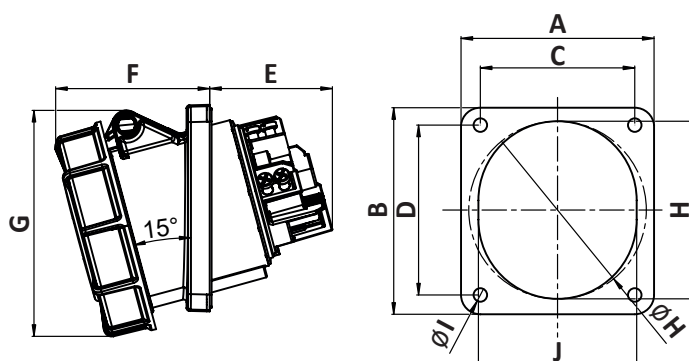

- Angled 15°
- Waterproof, IP67
- Screw terminals
- Brass with lamellar contact CuBe with pilot contact
- With 107 x 100mm Flange



Dimensions (mm)			
Poles	3	4	5
Current	63A		
Flange A	100	100	100
Flange B	107	107	107
Hole Spacing C	77	77	77
Hole Spacing D	85	85	85
E	64	64	64
F	80	80	80
G	119	119	119
H	92	92	92
I	7	7	7
J	82	82	82
Weight (g)	491	536	591

Voltage		230 V~	400 V~
Frequency		50/60 Hz	50/60 Hz
Designation		3p = 6h 4p/5p = 9h	3p = 9h 4p/5p = 6h
Current	Poles	Part No.	Part No.
63A	3	POWtecS-363B-P8467	-
63A	4	POWtecS-463B-P8467	POWtecS-463R-P8467
63A	5	POWtecS-563B-P8467	POWtecS-563R-P8467